

Acoplamento Elástico - CONBORFLEX

MODELO PADRÃO



Tabela I - Modelo AEC

Modelo Ref.	Torque nominal Nm	Ø do Eixo Máximo mm	Rotação Máxima Min-1	B mm	C mm	D mm	E mm	Peso kg	Gd2 kg/m²	Torque paraf. Nm	Tolerância de Alinhamento			Corpo Elástico Ref.
											Angular Grau	Paralelo mm	Axial mm	
AEC 086	40	20	4500	30,0	85,0	8,0	58,0	0,8	0,00	2,0	2	0,70	1,00	CC-086
AEC 104	70	25	4500	38,5	104,0	8,0	70,0	1,3	0,00	7,0	2	0,75	1,00	CC-104
AEC 136	160	35	4500	52,5	136,0	8,0	106,0	3,0	0,00	7,0	2	1,00	1,50	CC-136
AEC 178	330	48	3600	72,5	178,0	22,0	130,0	6,0	0,01	7,0	2	1,30	2,00	CC-178
AEC 178 H	500													CC-178 H
AEC 210	850	60	3600	95,0	208,0	24,0	158,0	10,2	0,02	16,0	2	1,60	2,50	CC-210
AEC 210 H	1050													CC-210 H
AEC 263	1350	70	2700	110,0	261,0	29,0	189,0	23,0	0,11	55,0	2	2,10	3,00	CC-263
AEC 263 H	1800													CC-263 H
AEC 310	2500	100	2700	143,0	310,0	24,0	232,0	39,2	0,22	55,0	2	2,50	3,50	CC-310
AEC 310 H	3000													CC-310 H
AEC 370	3700	100	2250	150,0	370,0	24,0	324,0	67,0	0,50	130,0	2	3,00	4,50	CC-370
AEC 370 H	4500													CC-370 H
AEC 402	5250	110	2070	170,0	397,0	20,0	358,0	98,0	0,92	130,0	2	3,50	5,00	CC-402
AEC 402 H	6750													CC-402 H
AEC 450	7500	120	1620	180,0	453,9	30,0	430,0	133,0	1,62	130,0	2	3,70	5,50	CC-450
AEC 450 H	9400													CC-450 H
AEC 550	13500	140	1350	210,0	549,1	85,0	475,0	170,0	2,72	265,0	2	4,20	6,00	CC-550
AEC 550 H	19400													CC-550 H
AEC 724	49000	220	910	432,0	726,0	100,0	480,0			265,0	2	5,00	6,00	CC-724

Acoplamento Elástico - CONBORFLEX

MODELO FI

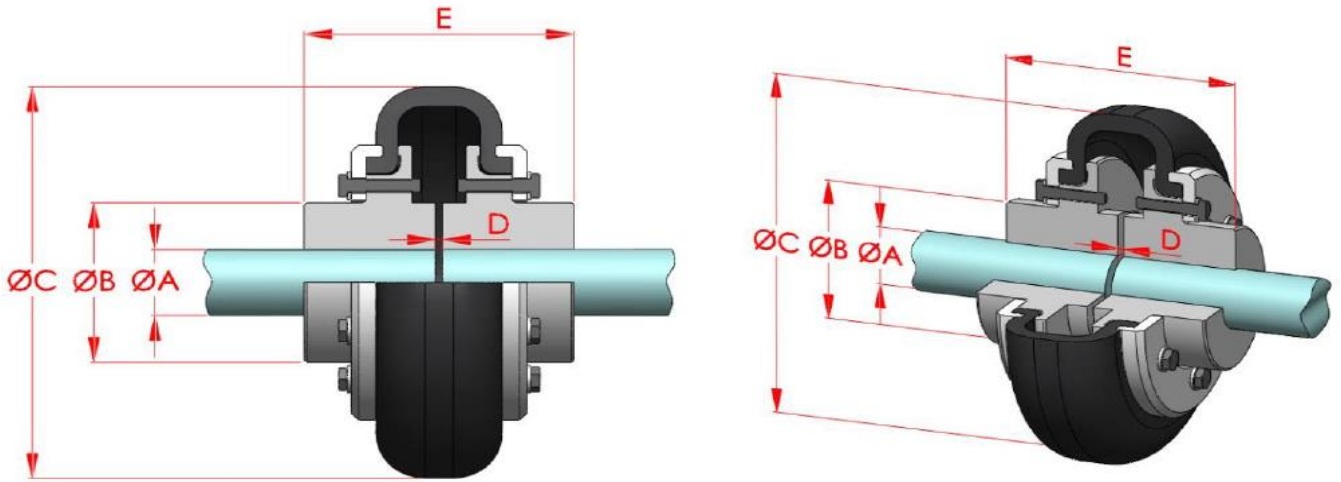

Tabela II - Modelo AEC - FI

Modelo Ref.	Torque nominal Nm	Ø do Eixo Máximo mm	Rotação Máxima Min-1	B mm	C mm	D mm	E mm	Peso kg	Gd2 kg/m²	Torque paraf. Nm	Tolerância de Alinhamento			Corpo Elástico Ref.
											Angular Grau	Paralelo mm	Axial mm	
AEC 086	40	32	4500	61,0	85,0	31,0	81,0	1,3	0,00	2,0	2	0,70	1,00	CC-086
AEC 104	70	35	4500	68,0	104,0	32,0	93,0	2,1	0,00	7,0	2	0,75	1,00	CC-104
AEC 136	160	45	4500	85,0	136,0	36,0	110,0	4,0	0,01	7,0	2	1,00	1,50	CC-136
AEC 178	330	60	3600	105,0	178,0	51,0	138,0	7,2	0,02	7,0	2	1,30	2,00	CC-178
AEC 178 H	500													CC-178 H
AEC 210	850	85	3600	140,0	208,0	60,0	160,0	13,6	0,06	16,0	2	1,60	2,50	CC-210
AEC 210 H	1050													CC-210 H
AEC 263	1350	110	2700	175,0	261,0	68,0	212,0	31,0	0,16	55,0	2	2,10	3,00	CC-263
AEC 263 H	1800													CC-263 H
AEC 310	2500	130	2700	205,0	310,0	70,0	250,0	48,0	0,36	55,0	2	2,50	3,50	CC-310
AEC 310 H	3000													CC-310 H
AEC 370	3700	170	2250	250,0	370,0	69,0	269,0	81,0	0,88	130,0	2	3,00	4,50	CC-370
AEC 370 H	4500													CC-370 H
AEC 402	5250	170	2070	225,0	397,0	79,0	319,0	102,0	1,31	130,0	2	3,50	5,00	CC-402
AEC 402 H	6750													CC-402 H
AEC 450	7500	190	1620	228,0	453,9	100,0	390,0	140,0	2,15	130,0	2	3,70	5,50	CC-450
AEC 450 H	9400													CC-450 H
AEC 550	13500	200	1350	236,0	549,1	160,0	380,0	160,0	3,47	265,0	2	4,20	6,00	CC-550
AEC 550 H	19400													CC-550 H
AEC 724	49000	260	910	444,0	726,0	150,0	430,0	505,0	19,600	265,0	2	5,00	6,00	CC-724

Acoplamento Elástico - CONBORFLEX

MODELO FG

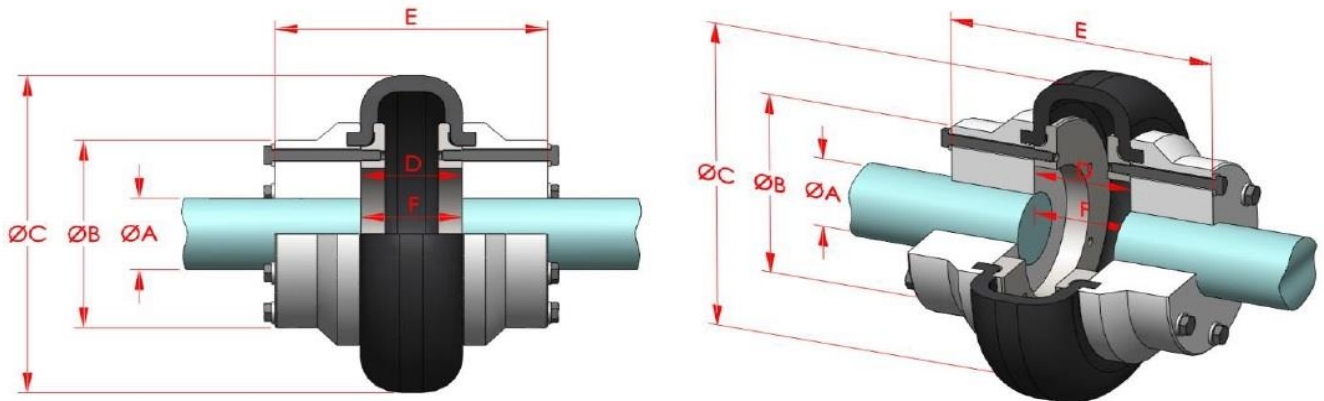
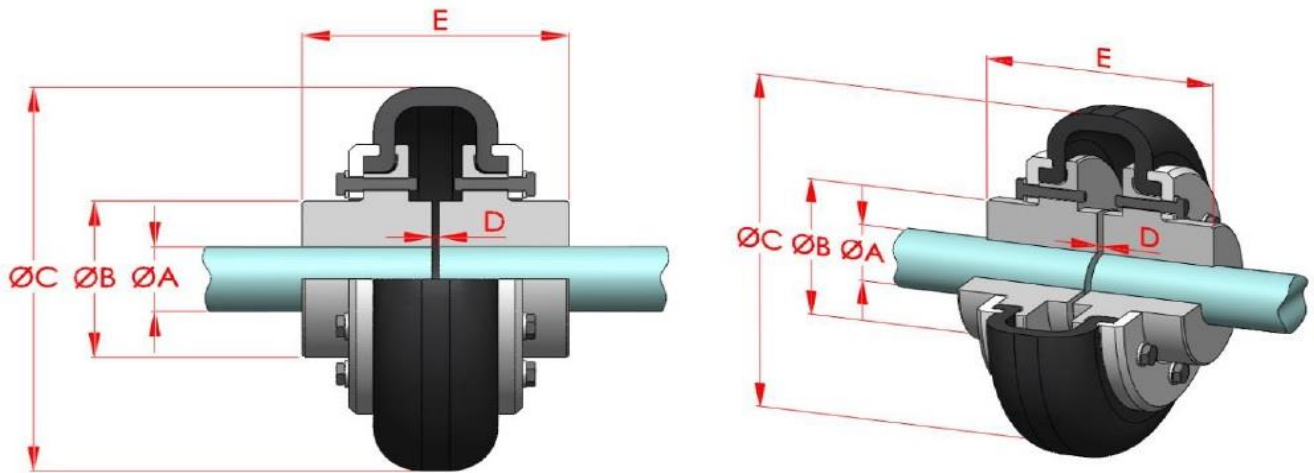

Tabela III - Modelo AEC - FG

Modelo Ref.	Torque nominal Nm	Ø do Eixo Máximo mm	Rotação Máxima Min-1	B mm	C mm	D mm	E mm	Peso kg	Gd2 kg/m ²	Torque paraf. Nm	Tolerância de Alinhamento			Corpo Elástico Ref.
											Angular Grau	Paralelo mm	Axial mm	
AEC 104	70	35	4500	38,5	104,0	3,0	70,0	1,3	0,00	7,0	2	0,75	1,00	CC-104
AEC 136	160	45	4500	52,5	136,0	3,0	101,0	3,0	0,00	7,0	2	1,00	1,50	CC-136
AEC 178	330	60	3600	72,5	178,0	3,0	111,0	3,5	0,01	7,0	2	1,30	2,00	CC-178
AEC 178 H	500													CC-178 H
AEC 210	850	85	3600	95,0	208,0	3,0	111,0	9,9	0,02	16,0	2	1,60	2,50	CC-210
AEC 210 H	1050													CC-210 H
AEC 263	1350	110	2700	110,0	261,0	3,0	141,0	21,2	0,10	55,0	2	2,10	3,00	CC-263
AEC 263 H	1800													CC-263 H
AEC 310	2500	130	2700	143,0	310,0	5,0	139,0	31,0	0,20	55,0	2	2,50	3,50	CC-310
AEC 310 H	3000													CC-310 H
AEC 370	3700	170	2250	170,0	370,0	5,0	187,0	51,0	0,46	130,0	2	3,00	4,50	CC-370
AEC 370 H	4500													CC-370 H
AEC 402	5250	170	2070	190,0	397,0	5,0	187,0	70,0	0,70	130,0	2	3,50	5,00	CC-402
AEC 402 H	6750													CC-402 H
AEC 450	7500	190	1620	200,0	453,9	6,5	219,0	93,0	1,17	130,0	2	3,70	5,50	CC-450
AEC 450 H	9400													CC-450 H
AEC 550	13500	200	1350	225,0	549,1	6,5	260,0	150,0	2,72	265,0	2	4,20	6,00	CC-550
AEC 550 H	19400													CC-550 H
AEC 724	49000	250	910	432,0	726,0	6,5	287,0	500,0	14,500	265,0	2	5,00	6,00	CC-724